



**POLISH ACADEMY OF SCIENCES**

**Systems Research Institute**

**DEVELOPMENT OF METHODS  
AND TECHNOLOGIES  
OF INFORMATICS  
FOR PROCESS MODELING  
AND MANAGEMENT**

**Editors:**

**Jan Studzinski  
Olgierd Hryniewicz**



**DEVELOPMENT OF METHODS AND  
TECHNOLOGIES OF INFORMATICS  
FOR PROCESS MODELING  
AND MANAGEMENT**

Polish Academy of Sciences • Systems Research Institute

**Series: SYSTEMS RESEARCH**

**Vol. 50**

---

Series Editor:

**Prof. Jakub Gutenbaum**

Warsaw 2006

**DEVELOPMENT OF METHODS  
AND TECHNOLOGIES OF INFORMATICS  
FOR PROCESS MODELING  
AND MANAGEMENT**

**Editors:**

**Jan Studzinski  
Olgierd Hryniewicz**

This publication was supported by Polish Ministry of Science and Higher Education

This book consists of papers describing applications of informatics in process modeling and management and in environmental engineering. Problems presented in the papers concern development of methods supporting process management, development of calculation methods for process modeling and development of technologies of informatics for solving some problems of environmental engineering. In several papers results of the research projects supported by the Polish Ministry of Science and Higher Education are presented.

Paper Reviewers:

Prof. Olgierd Hryniewicz

Dr. Jan Studzinski

Text Editor: Anna Gostynska

Copyright © Systems Research Institute of Polish Academy of Science,  
Warsaw 2006

Systems Research Institute of Polish Academy of Science  
Newelska 6, PL 01-447 Warsaw

Section of Scientific Information and Publications  
e-mail: biblioteka@ibspan.waw.pl

**ISBN 83-894-7507-3**

**9788389475077**

**ISSN 0208-8029**

## CHAPTER 1

# **Process management and management tools**



## USE OF JAVA 2 ENTERPRISE EDITION TECHNOLOGY IN THE DEVELOPMENT OF THE ENTERPRISE RESOURCE PLANNING AND THE CUSTOM-RELATIONSHIP MANAGEMENT

*Rafał BONIECKI*

University of Technology and Agriculture in Bydgoszcz  
<*raboni@atr.bydgoszcz.pl*>

***Abstract:** In this article the ERP and CRM systems have been discussed on the example of the firm dealing with the recycling of waste products. This firm has been operating within the European Union area. Open source Java 2 Enterprise Edition (J2EE™) application server is being used by this company. Experience connected with the application of this system point at the necessity for further development of the mobile technologies.*

**Keywords:** ERP, CRM, JBoss, CSTA.

### 1. Introduction

The challenge to IT and computing professionals today is to efficiently develop and deploy distributed applications and Web services for use on both corporate intranets and over the Internet. Companies that can do this effectively are sure to gain strategic advantage in the information economy.

Today, more and more developers want to write distributed transactional applications for the enterprise and leverage the speed, security, and reliability of server-side technology. Everybody knows that in today's fast-moving and demanding world of e-business and information technology, enterprise applications have to be designed, built, and produced at lower costs, with greater speed, and with fewer resources than ever before.

To reduce costs and fast-track enterprise application design and development, the Java™2 Platform, Enterprise Edition (J2EE™) technology provides a component-based approach to the design, development, assembly, and deployment of enterprise applications. The J2EE platform offers a multitiered distributed application models, the ability to reuse components, integrated Extensible Markup Language (XML)-based data interchange, a unified security model, and flexible transaction control.

Not only can supplier deliver innovative customer solutions to market faster than ever, but the company platform-independent J2EE component-based solutions

are not tied to the products and application programming interfaces (APIs) of any one supplier.

The Java 2 Platform, Enterprise Edition is a standard set of Java technologies that streamline the development, deployment, and management of Web services and enterprise applications. The J2EE platform provides a functionally complete environment, one in which it is possible to develop a large class of Web services and enterprise applications using J2EE technologies.

Furthermore, developers can be assured that applications written for the J2EE platform will run on any J2EE-compatible server.

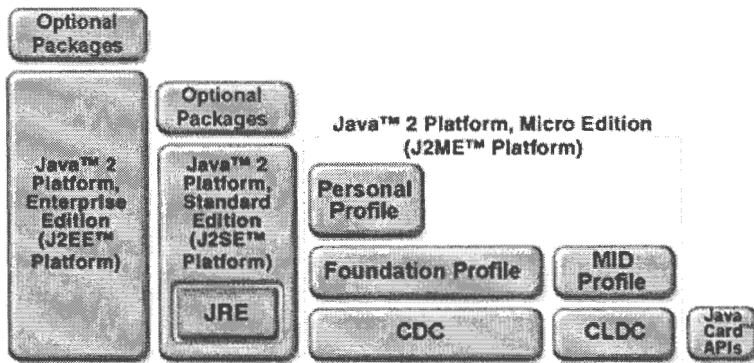

**Figure 1.** Family the Java™2 Platform.

Overall, the J2EE platform provides numerous benefits for organizations developing these Web service applications, including a simplified development model:

- industrial-strength scalability,
- support for existing information systems,
- choices in servers, tools and components,
- a simple, flexible security model.

Suppliers and customers enjoy the freedom to choose the products and components that best meet their business and technological requirements.

## 2. Background

The development of modern technologies affects the economy. The essence of this phenomenon directly influences the functioning of economic organizations. Therefore, the non-material resources such as knowledge and experience, especially information, become of particular importance. The contemporary market and espe-



cially processes leading to its globalisation present a challenge to economic companies.

The companies increasingly search for the new solutions concerning management so as to meet the market's expectations. In such a model of the company information becomes the most important resource in the firm.

The development of companies caused by rapid changes in their surroundings, has led to the increase of the new technologies connected with obtaining, collecting and storing information.

Information has become the basic factor in the process of production and this caused the rapid development of teleinformatic technologies.

The changes in the market force the companies to adapt to the new solution.

Changes occurring in the way of managing the companies cause that information and knowledge become the most important factors of production.

### **3. Java 2 Enterprise Edition (J2EE™) application**

JBoss Application Server (JBoss AS) is the market-leading, open source Java 2 Enterprise Edition (J2EE™) application server, delivering a high-performance, enterprise-class platform for e-business applications. Combining a robust, yet flexible, architecture with a no-cost open source software license, JBoss AS has quickly become the most popular middleware system for developers, independent software vendors (ISVs), and enterprises alike.

JBoss AS not only offers the performance and reliability expected from an industrial-strength application platform, it enables customers to scale technically and economically as well. With its revolutionary service-oriented architecture (SOA), JBoss AS ensures that applications are developed, deployed, integrated, and managed in a consistent manner.

JBoss AS fully supports the Web Services standards required in the J2EE 1.5 specification, enabling different applications to work together, even if they are running on different operating systems and hardware architectures, and using different application infrastructures and programming languages. This technology independent interoperability enables IT organizations to maximize the value of their existing solutions, as well as enable enterprise application integration and eliminate corporate silos.

The company, on the basis of which I am going to discuss the implementation of JBoss AS, deals with the collection of used oil, waste products, oil waste, tyres waste and waste paper. The company activity comprises the whole area of Poland.

Part of the collected products is processed within the company, the rest is stored and then delivered to the recycling companies in Poland and Germany.

The firm has its own transport consisting of four cars and 35 trucks which are adapted to carry dangerous cargo. Part of the deliveries to the recyclers is carried out by rail.

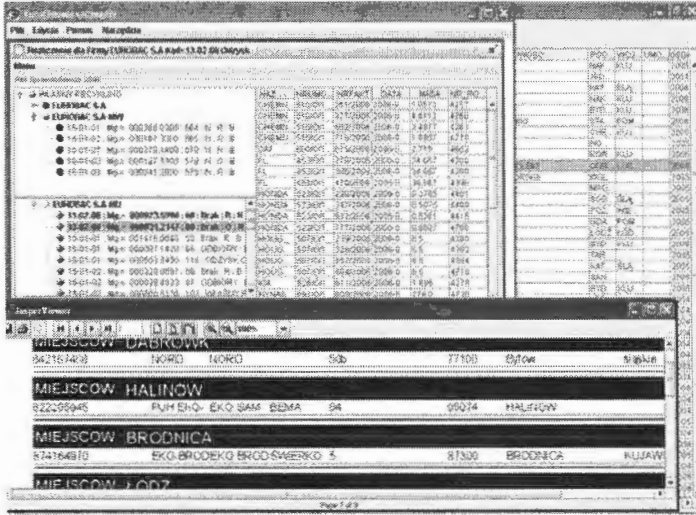

Figure 2. The window shows view of the Java application.

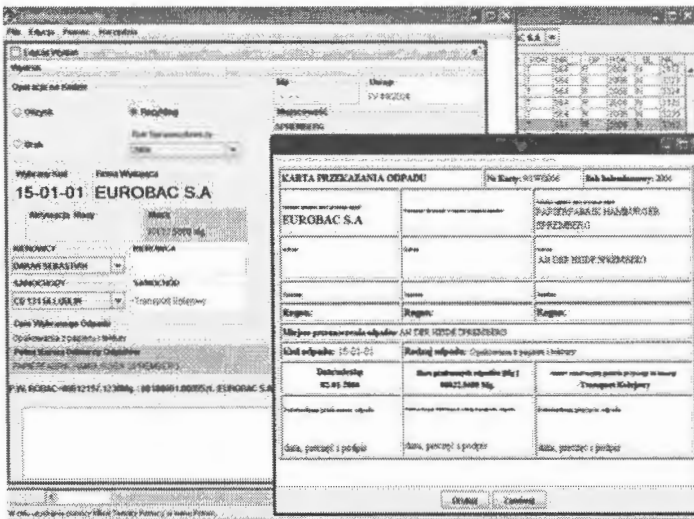

Figure 3. The window shows view of the Java application.

Over the past few years the market conditions have made the firms struggle to optimize the costs and win the clients.

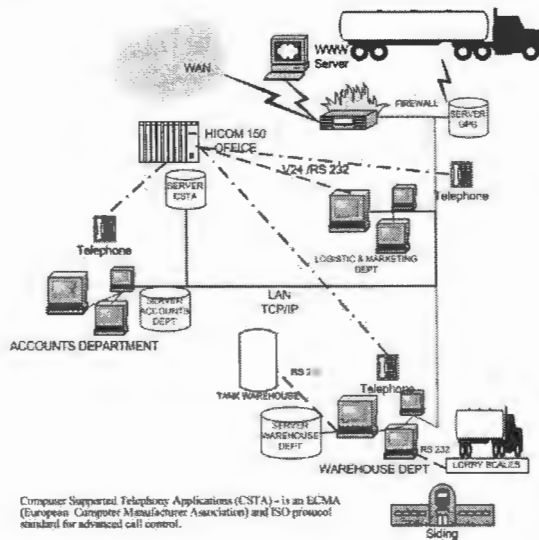

Figure 4. The medium-sized enterprise architecture.

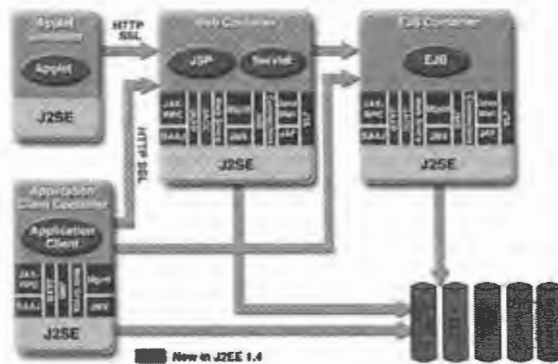

Figure 5. Multitiered Applications.

The analysis of the company referring both to the internal and external supply chain management is aimed to evaluate its effectiveness and analyse its important factors.

The expected savings in costs and expenses from the strategic management improvement will help to reduce the costs and to achieve its target profit.

As a result of conducted analyses, the following strategies increasing the profit were developed:

- optimizing the functioning of transport ,
- increasing the client's satisfaction through the improvement of services.

The new teleinformatic technologies have been applied in order to implement the new strategies, for example, the GPS technology devices have been installed in all the trucks.

Thanks to that, the company has got constant monitoring system of the trucks carrying the cargo. The systems enables the register of such parameters as:

- speed,
- idle time,
- driving time,
- the level of fuel.

Owing to this system the logistics department can choose the best routes for the particular trucks.

Besides the on-line monitoring of trucks carrying dangerous waste, it is also important to store the information about the vehicles' routes.



**Figure 6.** The window shows view of the GPS application.

The process of reading the tachograph charts has been automated. The corruption existing on the market of fuel has made the company to control the fuel

consumption regularly through the application of additional systems collecting the data of the vehicles connected to the Engine Electronic Control Unit (EECU) of the trucks.



**Figure 7.** Analogue tachograph has been used for many years by the company.



**Figure 8.** The location of the diagnostic connector.

The company can benefit from using this application by managing certain vehicle events such as: Fuel consumption, PTO hours, Cruise control usage.

Information is downloaded to a PC directly from the EECU and stored in the database of the software program. The information then forms the basis for production of various reports. The company can view the data in several different ways such as: Trend Report, Trip Report, Total Report and Service Report.

Besides the information above, the data about the fuel consumption and the way of operating the car by the driver is also provided.

On the premises of the company there is a lorry scales which is used in conjunction with a communication interface, connected to a serial COM port on the rear of the PC.

To improve the level of the client's service, Computer Supported Telephony Applications (CSTA) for Siemens Hicom 150 E Office has been applied.

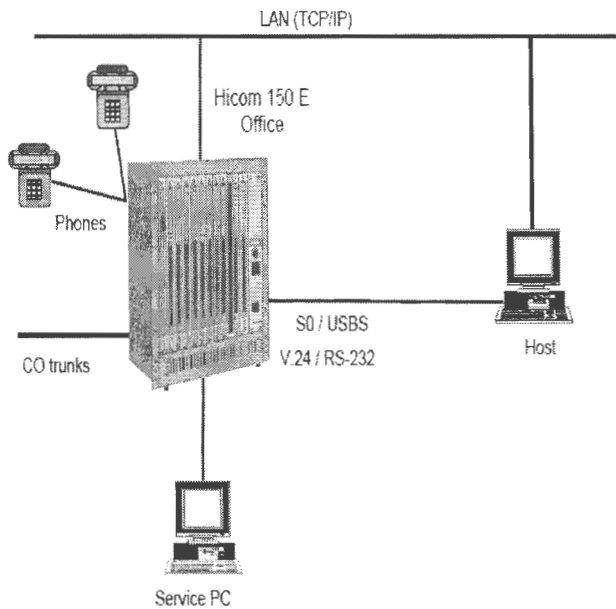

**Figure 9.** Computer Supported Telephony Applications (CSTA) - is an ECMA (European Computer Manufacturer Association) and ISO protocol standard for advanced call control. CSTA is used by a wide range of business communication applications, such as ERP and CRM applications.

Thanks to the connection of this system to the clients' database it is possible to make the record of services with the chosen client. This system gives the opportunity of the objective evaluation of employees in the logistics and marketing departments.

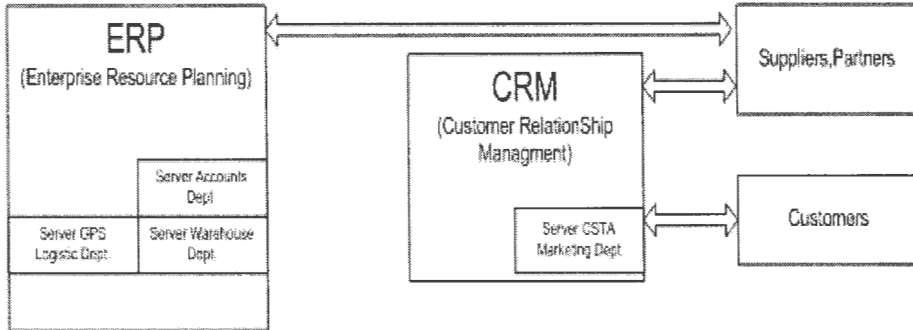

**Figure 10.** E-business system.

The effective and efficient strategies of information management, that is obtaining and processing information, depends on the quality of the informatic system.

#### 4. Summary

The applied strategy has improved company's operating profit. It was possible to achieve this profit thanks to the application of the J2EE technology which has enabled to manage the information supplied by the company's chosen servers. The rapid development of J2EE technology creates the new prospects for the development of the teleinformatic technologies in the company.

This independent interoperability technology enables IT organizations to maximize the value of their existing solutions. It also enables company application integration.

#### References

- Abt S. (1998) *Zarządzanie logistyczne w przedsiębiorstwie*. PWE, Warszawa.
- Blaik P. (2001) *Logistyka*. Polskie Wydawnictwo Ekonomiczne, Warszawa.
- Christopher M. (1997) *Sieci i logistyka: Zarządzanie relacjami w ramach łańcucha dostaw*. W: *Zarządzanie łańcuchem dostaw, Logistics '98*. Polskie Towarzystwo Logistyczne, Poznań.
- Todman Ch. (2003) *Projektowanie hurtowni danych zarządzanie kontaktami z klientami CRM (Desining a Data Warehouse: Supporting Customer Relationship Management)*. Wydawnictwa Naukowo-Techniczne, Warszawa.
- Schild H. (2005) *Java: The Complete Reference, J2SE 5 Edition*. McGraw-Hill Companies.
- Web site, <http://java.sun.com/products/jms/>.
- Web site, <http://java.sun.com/blueprints>.
- Web site, <http://java.sun.com/javaee/releases.jsp>

Web site , <http://java.sun.com/j2ee> .

Web site,

[http://enterprise.usa.siemens.com/company/white/2gip/mainColumnParagraphs/026/document/HiPath\\_real-time\\_IP\\_systems\\_White\\_Paper\\_en.pdf](http://enterprise.usa.siemens.com/company/white/2gip/mainColumnParagraphs/026/document/HiPath_real-time_IP_systems_White_Paper_en.pdf)





Jan Studzinski, Olgierd Hryniewicz (Editors)

**DEVELOPMENT OF METHODS AND TECHNOLOGIES  
OF INFORMATICS FOR PROCESS MODELING  
AND MANAGEMENT**

The purpose of this publication is to popularize application of informatics in process modeling and management and in environmental engineering. The papers published are thematically selected from the works presented during the conference '*Multi-accessible Computer Systems*' organized by the Systems Research Institute and the University of Technology and Agriculture in Bydgoszcz for several years already in Ciechocinek. Problems presented in the papers concern: development of quality and quantity methods supporting the process management, development of quantity methods for process modeling and simulation, development of technologies of informatics for solving problems of environmental engineering. In several papers results of research projects supported by the Polish Ministry of Science and Higher Education are presented.

**ISBN 83-894-7507-3**

**9788389475077**

**ISSN 0208-8029**

---

---